

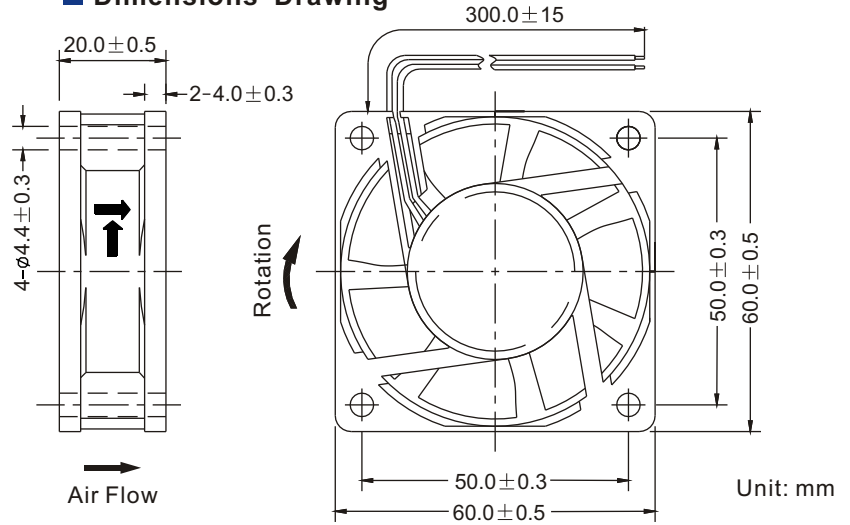

■ Dimensions Drawing

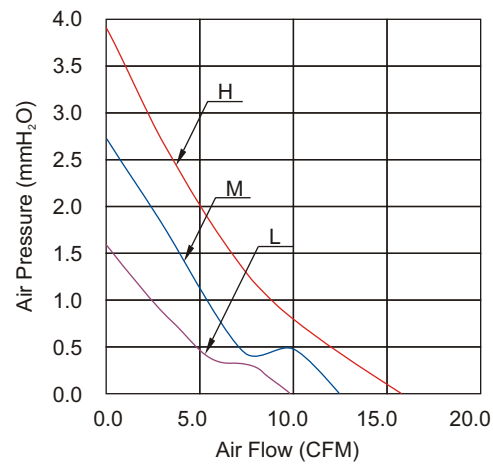

■ Performance Curves



General Specification:

- Frame and Impeller : Thermal Plastic , UL 94V-0
- Lead Wires : UL Type
(+) : Red (-) : Black
- Operation Temperature : -10°C~70°C、
35%~85%RH
- Storage Temperature : -40°C~80°C、
35%~85%RH



Listed Model	Bearing System	Rated Voltage	Operation Voltage	Rated Current	Rated Speed	Air Flow	Air Pressure	Noise Level	Available Features (Optional)				Weight
		VDC	VDC	A	RPM	CFM	mmH ₂ O	dBA	Tachometer Output	Rotation Detector	Thermal Control	Pulse Width Modulation	g
RDH6020S	Sleeve	12	6.0~13.8	0.16	4,000	16.0	3.9	30	•	•	•	•	50
RDM6020S			6.0~13.8	0.12	3,300	13.2	2.7	25	•	•	•	•	
RDL6020S			6.0~13.8	0.08	2,500	9.9	1.6	20	•	•	•	•	
RDH6020B	Ball		6.0~13.8	0.16	4,000	16.0	3.9	30	•	•	•	•	
RDM6020B			6.0~13.8	0.12	3,300	13.2	2.7	25	•	•	•	•	
RDL6020B			6.0~13.8	0.08	2,500	9.9	1.6	20	•	•	•	•	
RDH6020S2	Sleeve	24	12.0~27.6	0.13	4,000	16.0	3.9	30	•	•			50
RDM6020S2			12.0~27.6	0.10	3,300	13.2	2.7	25	•	•			
RDL6020S2			12.0~27.6	0.08	2,500	9.9	1.6	20	•	•			
RDH6020B2	Ball		12.0~27.6	0.13	4,000	16.0	3.9	30	•	•			
RDM6020B2			12.0~27.6	0.10	3,300	13.2	2.7	25	•	•			
RDL6020B2			12.0~27.6	0.08	2,500	9.9	1.6	20	•	•			

Notes: ©All readings are typical values at rated voltage.
©Specifications are subjected to change without prior notice.