

■ Dimensions Drawing

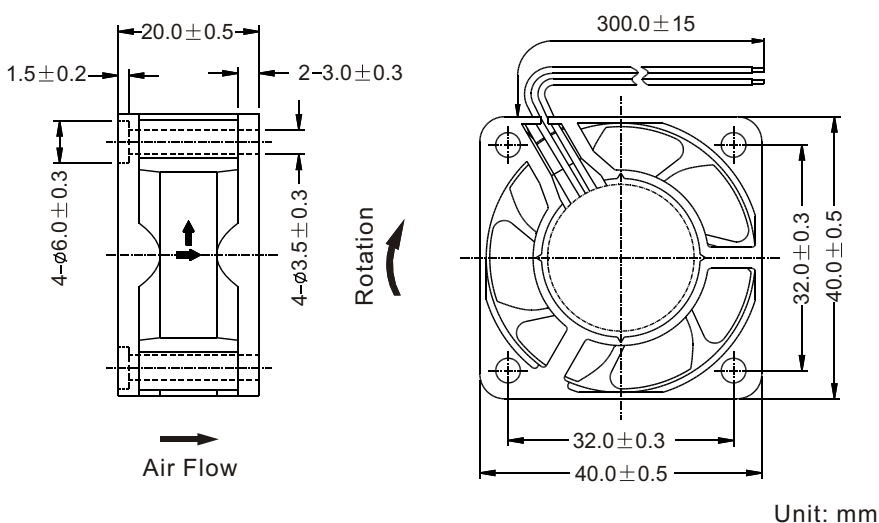

Unit: mm

General Specification:

- Frame and Impeller : Thermal Plastic , UL 94V-0
- Lead Wires : UL Type
(+) : Red (-) : Black
- Operation Temperature : -10°C~70°C、
35%~85%RH
- Storage Temperature : -40°C~80°C、
35%~85%RH



■ Performance Curves

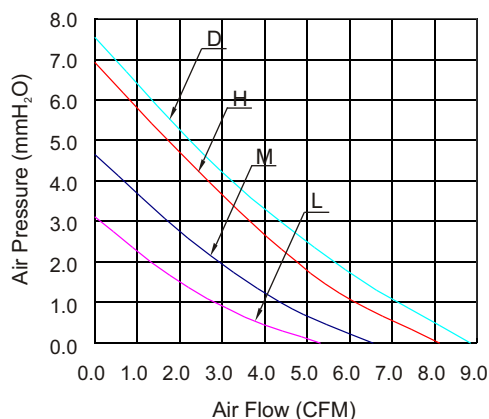

Listed Model	Bearing System	Rated Voltage	Operation Voltage	Rated Current	Rated Speed	Air Flow	Air Pressure	Noise Level	Available Features (Optional)				Weight g
		VDC	VDC	A	RPM	CFM	mmH ₂ O	dBA	Tachometer Output	Rotation Detector	Thermal Control	Pulse Width Modulation	
RDD4020S5	Sleeve	5	3.5~5.75	0.40	8,000	8.9	7.5	33	•	•			29
RDH4020S5			3.5~5.75	0.28	7,500	8.1	6.9	31	•	•			
RDM4020S5			3.5~5.75	0.25	6,200	6.6	4.7	27	•	•			
RDL4020S5			3.5~5.75	0.20	5,000	5.3	3.1	23	•	•			
RDD4020B5	Ball		3.5~5.75	0.40	8,000	8.9	7.5	33	•	•			
RDH4020B5			3.5~5.75	0.28	7,500	8.1	6.9	31	•	•			
RDM4020B5			3.5~5.75	0.25	6,200	6.6	4.7	27	•	•			
RDL4020B5			3.5~5.75	0.20	5,000	5.3	3.1	23	•	•			
RDH4020S	Sleeve	12	6.0~13.8	0.12	8,000	8.9	7.5	33	•	•			
RDH4020S			6.0~13.8	0.12	7,500	8.1	6.9	31	•	•			
RDM4020S			6.0~13.8	0.10	6,200	6.6	4.7	27	•	•			
RDL4020S			6.0~13.8	0.06	5,000	5.3	3.1	23	•	•			
RDH4020B	Ball		6.0~13.8	0.12	8,000	8.9	7.5	33	•	•			
RDH4020B			6.0~13.8	0.12	7,500	8.1	6.9	31	•	•			
RDM4020B			6.0~13.8	0.10	6,200	6.6	4.7	27	•	•			
RDL4020B			6.0~13.8	0.06	5,000	5.3	3.1	23	•	•			
RDD4020S2	Sleeve	24	12.0~27.6	0.09	8,000	8.9	7.5	33	•	•			
RDH4020S2			12.0~27.6	0.07	7,500	8.1	6.9	31	•	•			
RDM4020S2			12.0~27.6	0.06	6,200	6.6	4.7	27	•	•			
RDL4020S2			12.0~27.6	0.05	5,000	5.3	3.1	23	•	•			
RDD4020B2	Ball		12.0~27.6	0.09	8,000	8.9	7.5	33	•	•			
RDH4020B2			12.0~27.6	0.07	7,500	8.1	6.9	31	•	•			
RDM4020B2			12.0~27.6	0.06	6,200	6.6	4.7	27	•	•			
RDL4020B2			12.0~27.6	0.05	5,000	5.3	3.1	23	•	•			

Notes: ©All readings are typical values at rated voltage.
©Specifications are subjected to change without prior notice.